

DConnect All-In-One

Descrizione

DConnect-All-In-ONE è un gateway pensato per soddisfare le più svariate esigenze del mercato DTI.

L'elettronica è controllata dal **microcontrollore ESP32-S3** e può essere utilizzata in **due modalità**:

- 1 - **Gateway**, da RS485 a WiFi/LTE CAT1, NB e CAT-M verso DCLOUD (cloud DTI) o AWS
- 2 - **Standalone**, in questa modalità la scheda processa una serie di segnali e invia i dati verso Cloud.

Per entrambe le versioni è possibile interfacciarsi con dispositivi esterni connessi in **Bluetooth**.

Il dispositivo prevede diverse configurazioni per poter essere connesso alla sola rete Wi-Fi/Bluetooth oppure connettersi alla rete mobile in **qualsiasi area geografica**.

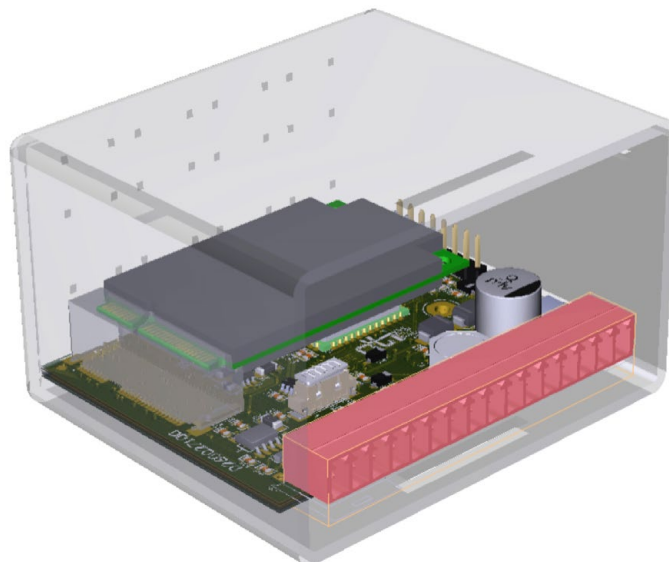

Description

DConnect-All-In-ONE is a gateway designed to meet the most diverse requirements of the DTI market.

The electronics are controlled by the **ESP32-S3 microcontroller** and can be used in **two ways**:

- 1- **Gateway**, from RS485 to WiFi/LTE CAT1, NB and CAT-M towards DCLOUD (DTI cloud) or AWS
- 2- **Standalone**, in this mode the card processes a series of signals and sends the data to Cloud.

For both versions, it is possible to interface with external **Bluetooth**-connected devices.

The device provides different configurations so that it can be connected to the Wi-Fi/Bluetooth network alone or connect to the mobile network in **any geographical area**.

Aggiornamento OTA (Over-The-Air)

Il dispositivo permette di gestire il **download dei file da cloud**, immagazzinarli all'interno della memoria del gateway ed effettuare l'aggiornamento di sé stesso e delle singole schede presenti nella macchina, tramite **RS485**.

OTA update (Over-The-Air)

The device allows **download of files from the cloud**, storing them within the gateway's memory and updating itself and the individual boards in the machine, via **RS485**.

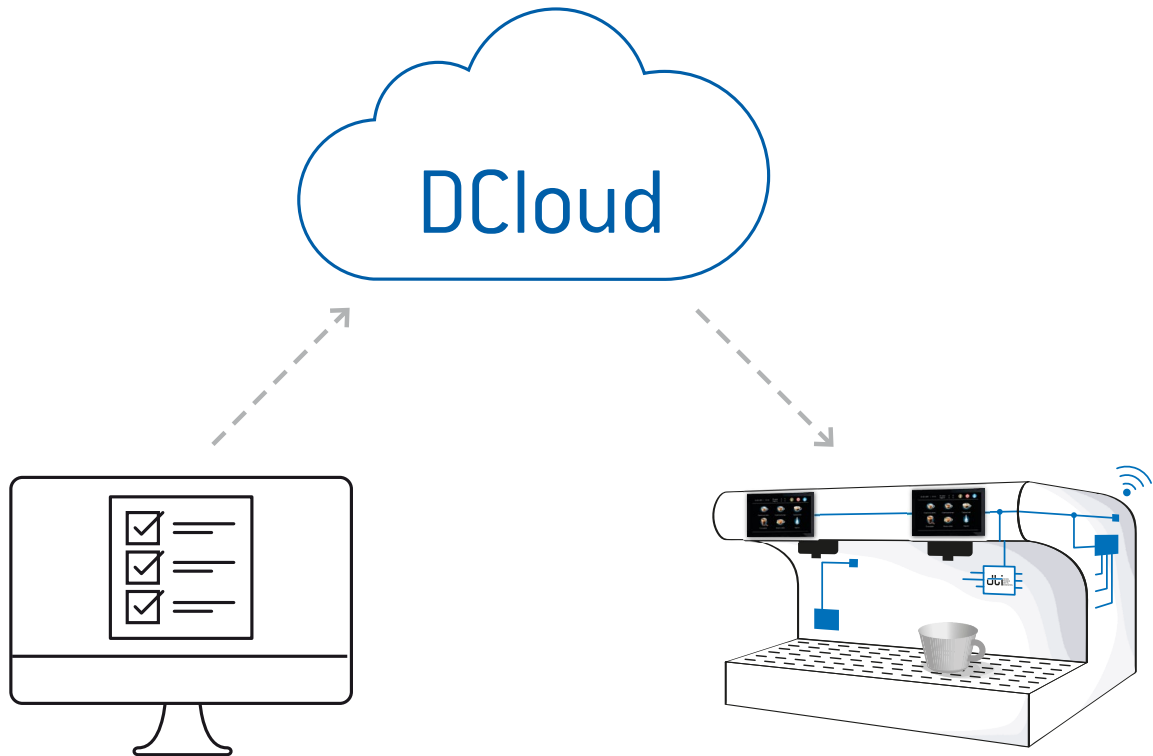

Configurazione Web Server

DConnect All-In-One permette di accedere tramite password all'interno del web server presente nel dispositivo per configurare la rete Wi-Fi, la rete Bluetooth, la rete LTE e tutti le impostazioni del dispositivo.

Web Server configuration

DConnect All-In-One allows password access to the web server on the device to configure the Wi-Fi network, Bluetooth network, LTE network and all device settings.

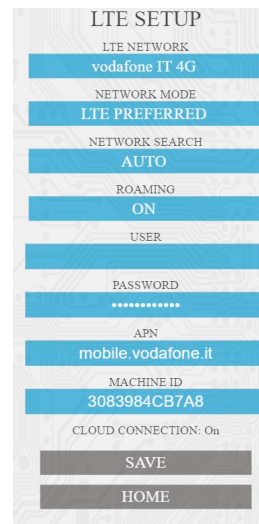
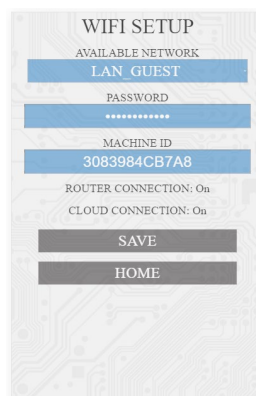
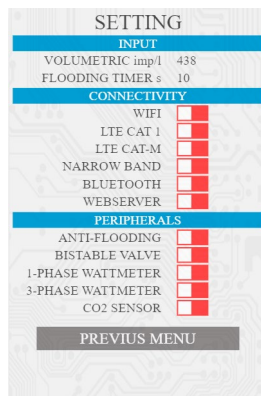



Caratteristiche tecniche / Technical features

Processor	
ESP32-S3-WROOM-1-N16	dual-core XTensa LX7 MCU 240MHz 512 KB internal Sram Flash 16 MB (Quad SPI)
Connectivity	
Bluetooth 5 (LE)	Speed: 125 Kbps, 500 Kbps, 1 Mbps, 2 Mbps
Wi-Fi	2.4 GHz 802.11 b/g/n Wi-Fi
Mobile V1	
LTE CAT-M1, LTE CAT-NB1 CAT-M Kbps 589 DL / 1119 UL CAT-NB Kbps 127 DL / 158.5 UL	CATEGORY LTE-FDD B1 / B2 / B3 / B4 / B5 / B8 / B12 / B13 / B14 / B18 / B19 / B20 / B25 / B26 / B27 / B28 / B31 / B66 / B71 / B72 / B85
GSM/GPRS/EDGE EGPRS Kbps 296 DL / 236.8 UL	GSM850MHz GSM 900MHz DCS1800MHz PCS 1900MHz
GNSS	GPS GLONASS BDS GALILEO
Mobile V2 (GLOBAL)	
LTE CAT1 LTE Mbps 10 DL / 5 UL	CATEGORY LTE-FDD (Frequency-Division Duplexing LTE) B1 / B2 / B3 / B4 / B5 / B7 / B8 / B12 / B13 / B14 / B18 / B19 / B20 / B25 / B26 / B27 / B28 / B66 LTE-TDD (Long-Term Evolution Time-Division Duplex) B38 / B40 / B41
WCDMA LTE Kbps 384 DL / 384 UL	BAND 1 BAND 2 BAND 4 BAND 5 BAND 6 BAND 8 BAND 19
GSM/GPRS/EDGE GPRS/EDGE Kbps 236.8 DL / 236.8 UL	GSM 850MHz GSM 900MHz DCS1800MHz PCS 1900MHz
GNSS	GPS GLONASS BDS
Mobile V3 (EMEA)	
LTE CAT1 LTE Mbps 10 DL / 5 UL	CATEGORY LTE-FDD (Frequency-Division Duplexing LTE) B1 / B2 / B3 / B4 / B5 / B7 / B8 / B20 / B28 / B66
GSM/GPRS/EDGE	GSM 850MHz GSM 900MHz DCS1800MHz PCS 1900MHz
Communication	
RS485	Modbus
Inputs	
Digital	Flow meter 0-12V
Analog/Digital	Pressure switch / transducer
Analog	Anti-flooding sensor
Analog	Temperature probe NTC 10k
Digital	Push button (reset)
Outputs	
Power	Solenoid Valve Bistable
Digital	RGB LED
Other Features	
Integrated Antenna for Wi-Fi and BLUETOOTH	

Dimensioni / Dimensions

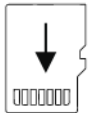
D530044300 - DCONNECT ALL-IN-ONE 

 SD CARD

 STATUS LED

RS485B	RS485A	+VRS485	GND	+5V	EV OUT2	EV OUT1	PRESS	+5V	LIV REF	LVL	NTC	GND	VOULM	GND	+VIN
1															16

 e-mail: info@dtindustry.com sito: www.dtindustry.com

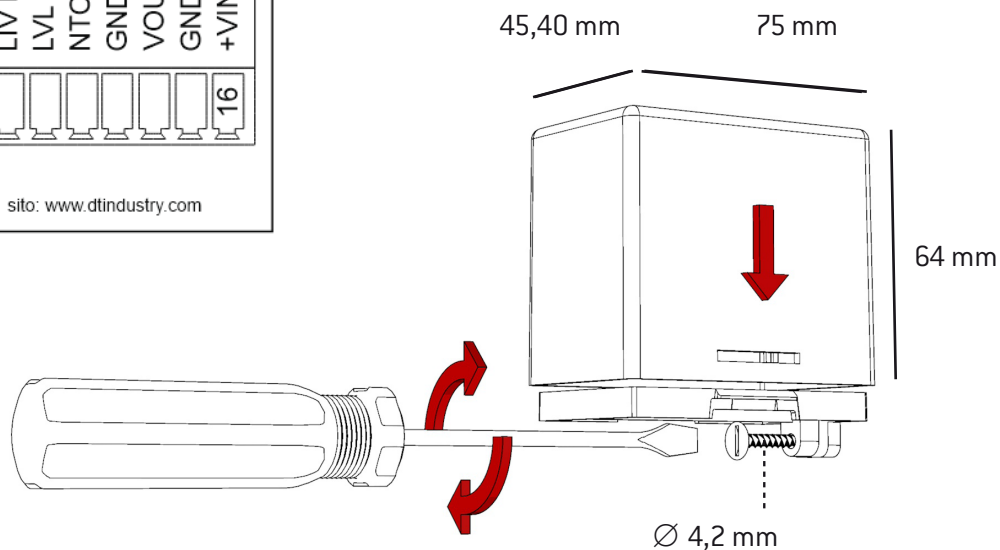

dti WHERE
PASSION
MEETS
INNOVATION

DTI srl

Via Palladio 11

33010 Tavagnacco (UD) ITALY

Tel: +39 0432 855071 - Fax: +39 0432 881848

info@dtindustry.com - www.dtindustry.com